

**NO. 1 PORTABLE SHEAR** (INSTRUCTIONS ON 3<sup>RD</sup> PAGE)

Index No.	Part Name	Part No.	Price
1	Frame, including right and left hand angles and latch casting (Note 1)	H-1	--
2	Handle Lever, with (2) riveted studs	H-4	\$78.76
3	Bushing for Handle Hole	H-7	18.05
4	Upper Blade -- carbon steel	H-8	126.34
5	Lower Blade -- carbon steel	H-9	77.12
6	Rod Cutter Bushing	H-10	14.77
7	Spring Housing	H-11	21.33
8	7/16-14 x 7/8 Screw (2 required)	H-63	1.31
9	1 1/2 x 1/2 Washer	H-34	2.46
10	5/16-24 x 1/2 Screw (5 required)	H-14	0.98
11	3/8-24 Hex Nut	H-15	0.82
12	Shoulder Stud	H-16	18.05
13	Holddown	H-17	34.46
14	1/2-20 Hex Nut	H-18	0.82
15	Holddown Bracket	H-19	22.97
16	Washer	305-26	0.66
17	Spring	H-21	27.89
18	3/8 x 3/4 SS Washer	H-20	2.46

Note 1. Price not shown, as replacement frame casting is not available.

**NO. 6 DEEP THROAT BENCH PUNCH**  
(INSTRUCTIONS ON 3<sup>RD</sup> PAGE)

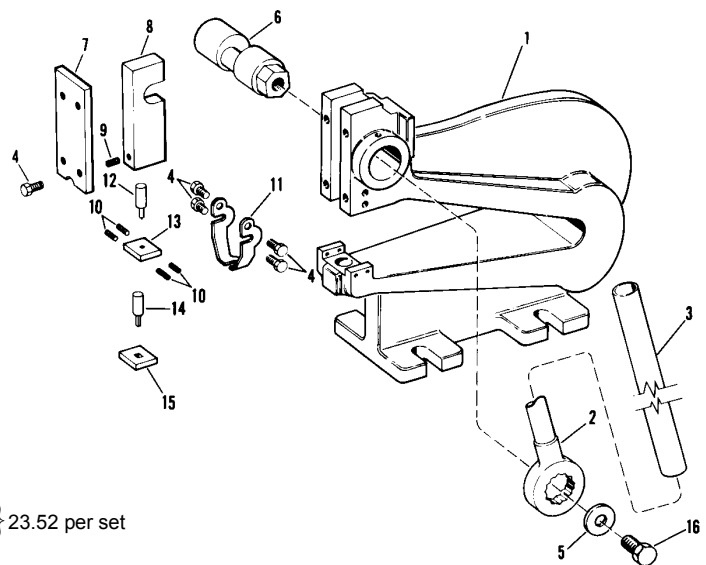

Index No.	Part Name	Part No.	Price
1	Frame Casting (Note 1)	H-65	--
2	Handle Casting	H-30	\$59.82
3	Handle Lever -- 29"	H-36	27.89
4	5/16-24 x 1/2 Screw (8 required)	H-14	0.98
5	1 1/2 x 1/2 Washer	H-34	2.46
6	Crank, Punching	H-52	63.99
7	Cover Plate	H-53	27.89
8	Punch Holder	H-55	93.52
9	3/8-16 x 1/2 Screw	H-56	1.48
10	1/4-20 x 1/2 Screw (4 required)	H-57	0.98
11	Holddown (Stripper) for Punch	H-68	27.89
12	Punch, 1/16" to 1/2" x 64ths -- Round	H-71	10.45
13	Die, 1/16" to 1/2" x 64ths -- Round	H-72	13.07
14	Punch, 1/8", 3/16", 1/4", 5/16", 3/8", 7/16", 1/2" -- Square	H-71SQ	45.74
15	Die, 1/8", 3/16", 1/4", 5/16", 3/8", 7/16", 1/2" -- Square	H-72SQ	54.88
16	7/16-14 x 3/4 Screw	H-44	1.15

} 23.52 per set

} 100.62 per set

## NO. 4 HANDNIB (INSTRUCTIONS ON 3<sup>RD</sup> PAGE)

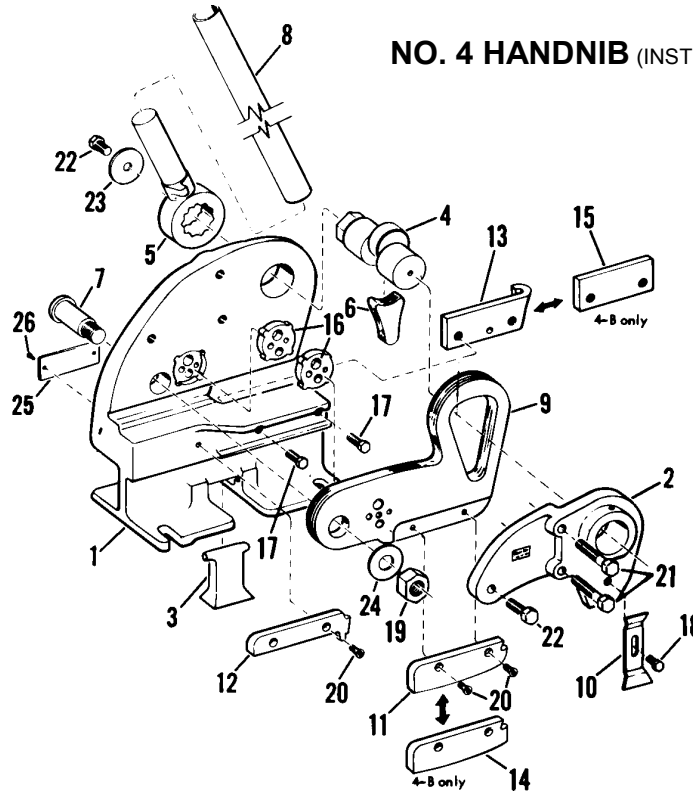

Index No.	Part Name	Part No.	Price
1	Frame Casting (Note 1)	H-27	--
2	Cover Casting	H-28	\$54.69
3	Latch Casting	H-22	25.64
4	Crank Casting	H-29	119.64
5	Handle Casting	H-30	59.82
6	Rocker Arm Assembly	H-31	39.38
7	Shoulder Stud	H-33	36.10
8	Handle Lever	H-36	27.89
9	Blade Holder Assembly	H-37	155.87
10	Holddown	H-45	19.69
11	Upper Outside Nibbling Blade -- 4A Only	H-47	91.88
12	Upper Inside Nibbling Blade -- 4A Only	H-48	91.88
13	Lower Nibbling Blade -- 4A Only	H-49	116.49
14	Upper Straight Shearing Blade, Carbon Steel -- 4B	H-50	52.50
15	Lower Straight Shearing Blade, Carbon Steel -- 4B	H-51	57.43
16	Rod Cutting Die (2 required)	H-54	37.74
17	7/16-14 x 7/8 Screw (2 required)	H-44	1.15
18	5/16-24 x 1/2 Screw	H-14	0.98
19	3/4-16 Nut	H-41	1.56
20	1/4-28 x 5/8 Screw (3 required)	33-10	0.98
21	7/16-14 x 1 1/4 Screw (2 required)	H-43	1.48
22	7/16-14 x 3/4 Screw (2 required)	H-44	1.15
23	1 1/2 x 1/2 Washer	H-34	2.46
24	1 1/2 x 3/4 Washer	H-35	2.46
25	Latch Casting Stop Plate	H-40	4.76
26	Stop Plate Pin (2 required)	27	0.49

Note 1. Price not shown, as replacement frame casting is not available.

**WHEN ORDERING PARTS, INDICATE PART NUMBER, MODEL NUMBER AND PRICE.**

## OPERATION AND MAINTENANCE INSTRUCTIONS FOR HEINRICH METALWORKING TOOLS.

Caution: Stock harder than Rockwell "B" 90/100 or Brinnell 190/220 should not be cut with the standard blades furnished. (Blades are water hardening tool steel, hardened to RC 58/60.)

### DO NOT USE BEYOND RECOMMENDED CAPACITIES.

(See pages 16 and 17.) Forcing the unit to cut stock heavier than rated capacity may distort the steel frame casting or damage the blades beyond the point of repair.

### INSTALLATION OF BLADES:

Before attempting to shear or nibble, be sure that the blades are properly engaged. There should be a minimum of clearance between the upper and lower blades, just sufficient to allow the upper blade to pass the lower blade. Blades are properly adjusted and "paper-cut tested" at the factory on all new units. Should it be necessary to reinstall blades, after sharpening, to replace upper outside nibbling blade with the inside nibbling blade, or to replace worn out blades, the blades should be installed in this manner:

1. Remove both upper and lower blades from the unit.
2. Place the operating handle in the closed position.
3. Securely attach the desired upper blade to the blade holder, making sure that the mounting surface on the blade holder is clean.
4. Place the lower blade into position against the milled surface of the frame casting, making sure again that the surface is clean. In the case of nibbling blades, the convex radius on the upper blade must engage the concave radius on the lower blade, with a minimum of clearance to allow movement.
5. Securely tighten all screws. When tightening screws on the lower nibbling blade, make sure that the lower blade does not move out of the engagement with the upper blade.
6. Should the blades fail to meet properly after tightening all screws securely, it may be necessary to place a paper shim of required thickness behind the lower blade to provide the proper minimum clearance.

**IMPORTANT -- USE OF HOLDDOWN:** Before shearing or nibbling, the holddown on the left side of the unit must be adjusted so that the bottom edge comes to within about 1/32" of the stock to be cut, when the stock is in a horizontal position. If the holddown is not properly adjusted before shearing or nibbling, the stock could wedge between the blades, causing possible damage to the frame casting and the blades.

### SHEARING:

The frames of all units are so constructed as to allow shearing of wide sheets. The part of the stock passing on the right side of the unit will become distorted because of the "shearing" action. Therefore, the part of the stock to be used should be on the left side of the shear. Shearing can most easily be done in short strokes, with the stock placed as far as possible to the back of the blades. For maximum effect of leverage, the handle should be gripped as near to the end as is comfortable or convenient. Do not

attempt to use a handle longer than the 29" handle furnished with the unit.

### NIBBLING:

Nibble bits of stock no deeper than 5/16", making sure that the stock does not extend beyond the "hook" of the lower blade. Nibble from right to left. Before attempting to use the inside nibbling blade, it is necessary to provide "heel" clearance in the stock by either punching or drilling a 1/4" (approx.) hole.

### ROD CUTTING:

Round stock in sizes 3/16", 1/4", 5/16" and 3/8" may be cut, using the appropriate hole size, which is stamped on the surface of the rod cutting die holder. The holes of the rod cutting die, inserted in the frame casting, should coincide with the holes of the die in the movable die holder, when the operating handle is in the full open position. Should the operator attempt to cut rods smaller than the hole, there will be a greater distortion of the stock. Stock should be inserted from the left side of the unit, and the stock should extend at least 1/4" beyond the cutting edges of the dies before cutting. Use a complete, quick, stroke when cutting rods. Rod cutting dies are press-fit into the movable die holder and the frame casting. They can be removed for replacement by knocking out, using a 3/16" steel pin in the knock-out hole provided for this purpose. Replace both dies, making sure to properly match the holes. Dies may be tapped into position with a hammer, using a soft object to protect the die edges. Before installing dies, make sure the mounting surfaces are clean.

### PUNCHING:

To install punch and die, follow these instructions. Insert punch fully into punch holder so that the flat on the punch is aligned with the set screw in the punch holder. Secure the set screw against the flat of the punch. Place die under the punch so that the tapered edges of the die face the four set screws. Lower the punch holder so that the punch enters the die hole. Tighten four set screws against tapered edges of die so that the punch is centrally located in the die hole. Holddown (stripper) must be attached in place to allow for stripping of stock off the punch. If edge of die hole becomes worn, top of die may be ground to restore sharp edge.

### SHARPENING BLADES:

Only the top cutting edge of the blades should be ground -- lengthwise, and with about a 5 deg. negative angle. Blades should be replaced if the inside surfaces become chipped, or when the blades have been ground down to the point where they no longer engage when in the full open position.

OCCASIONAL OILING IN THE OIL HOLE AT THE TOP OF THE UNIT IS RECOMMENDED. ALL OPERATING PARTS SHOULD BE KEPT CLEAN AND PROTECTED AT ALL TIMES FROM RUST.